



DOMO BARANDILLA



Referencia	Sección	Designación	Peso g / ml	Perímetro dm2 / ml
525		Tebo 40x40mm con portatornillos	678	32.3
3500		Anclaje pasamanos	481	20.9
3501		Pasamanos redondo	1037	47.8
3502		Pilastra	1291	22.1
3503		Portavidrio	518	24.7
3504		Tapa anclaje	210	12.2
3505		Tapa portavidrio	181	12.0
3506		Pasamanos ovalado para vidrio	1096	49.3
3507		Perfil para vidrio completo	516	24.6
3508		Barrotillo ovalado	310	15.9
5266		Pasamanos redondo 50	481	24.2
5267		Anclaje pasamanos 50	826	41.2
5276		Pasamanos 70	940	43.6
5277		Tapa anclaje pasamanos 70	281	15.1
5278		Anclaje pasamanos 70	464	21.7

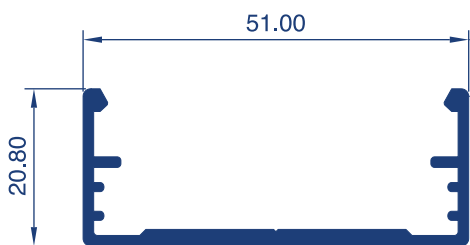

Ref. 3500

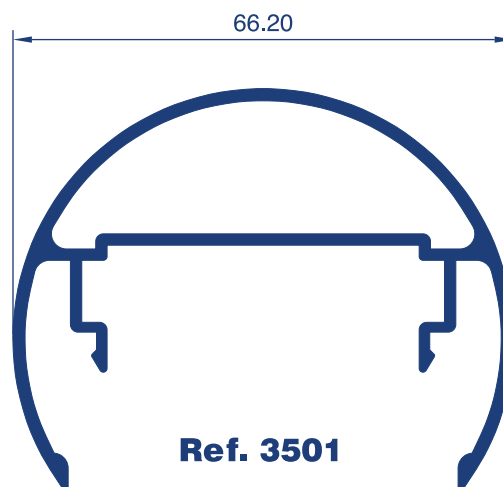

Ref. 3501

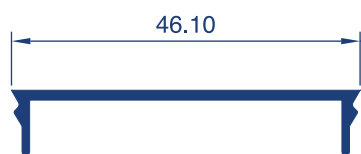

Ref. 3504

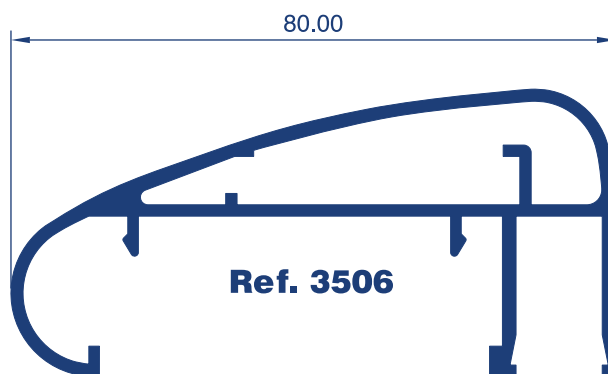

Ref. 3506

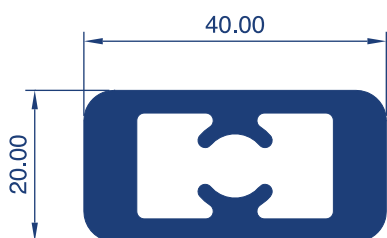

Ref. 3502

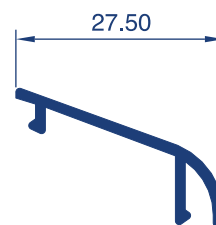

Ref. 3505

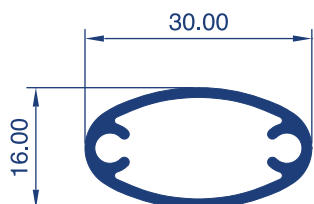

Ref. 3508

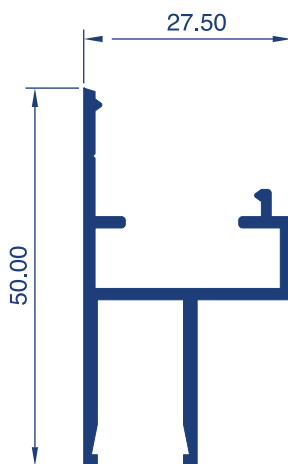

Ref. 3503

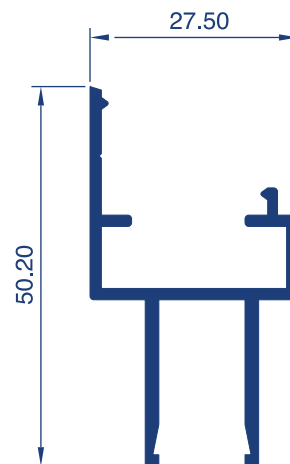

Ref. 3507

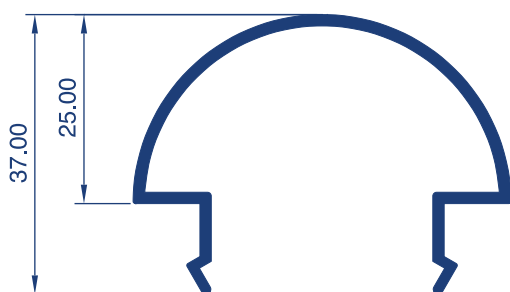
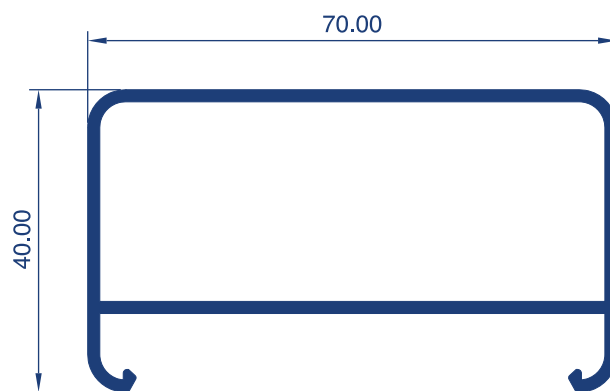
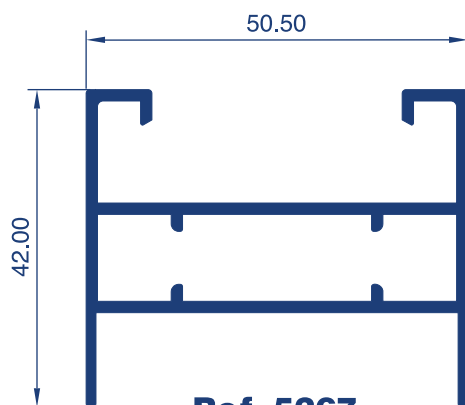
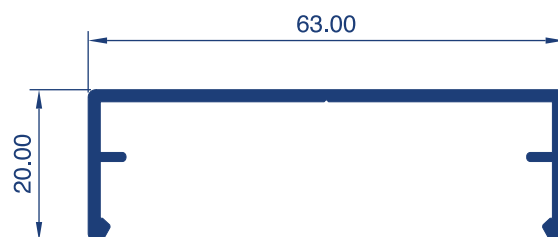
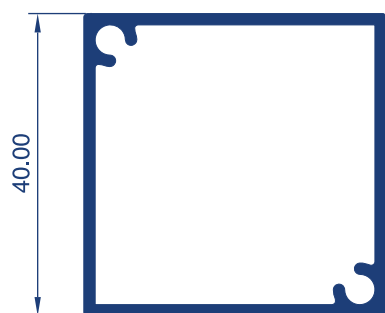
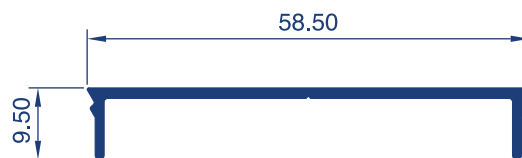
**Ref. 5266****Ref. 5276****Ref. 5267****Ref. 5278****Ref. 525****Ref. 5277**

