



# Portadas Rústicas

(Volet battant)

# Provence



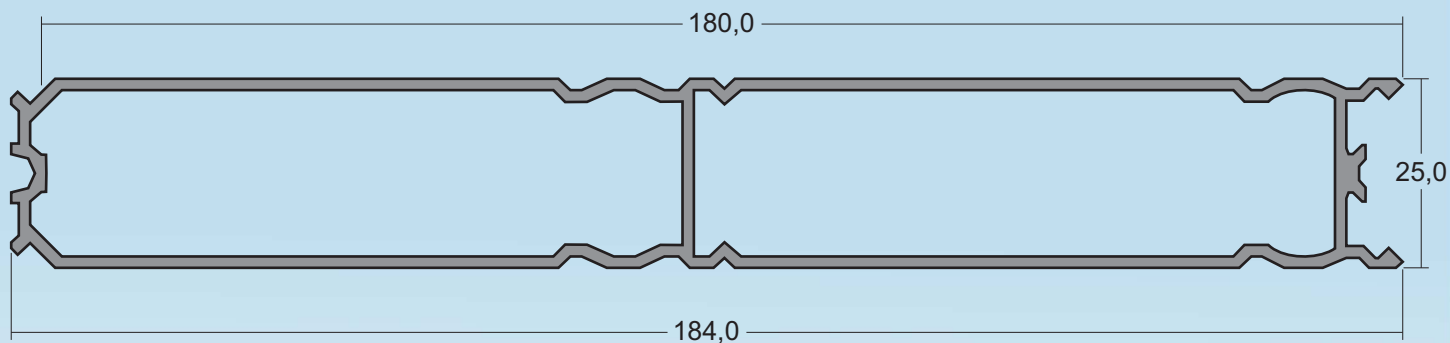

**PT.975**

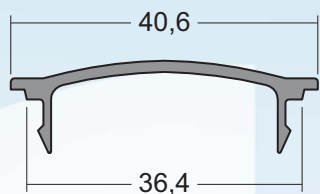

**PT.850**

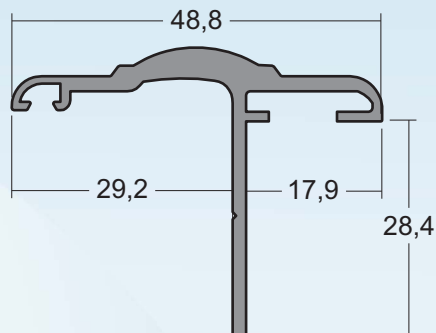

**PT.605**

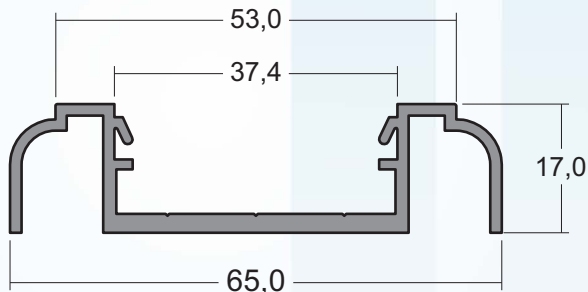

**PT.750**

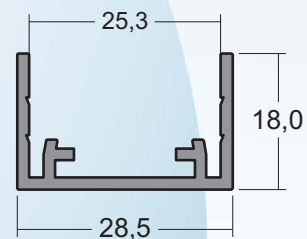

**PT.150**

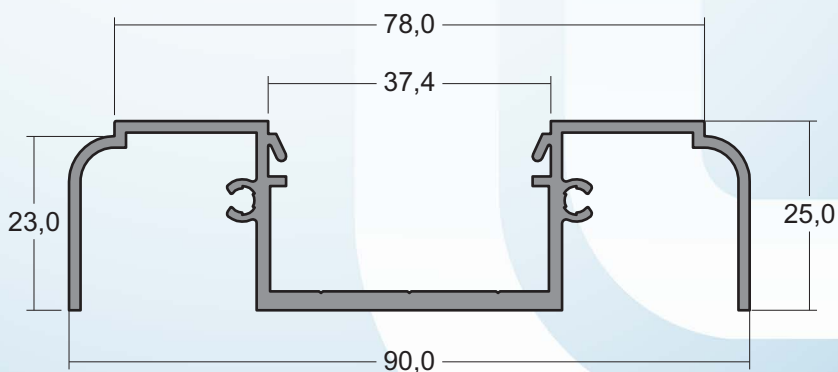

**PT.650**

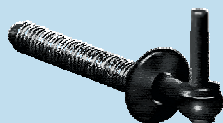

X.29.0017

Perno Dobradiça Fixação Parede

unid.



X.29.0018

Dobradiça 1ª fl p/ Portada de 1 e 2 folhas

unid.



X.29.0019

Dobradiça 1ª fl p/Portada de 3 e 4 folhas

unid.

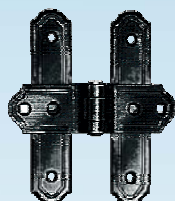

X.29.0020

Dobradiça 3ª e 4ª folha

unid.

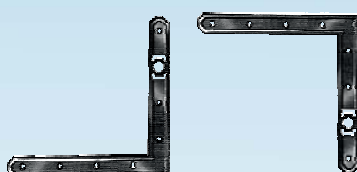

X.59.0092

Espelho Angulo para dobradiça 1ª folha

Par



X.59.0094

Espelho Angulo complementar

unid.



X.59.0093

Espelho dobradiça intermédia (portas)

Unid.



X.33.0093

Ponto de fecho duplo

unid.



X.33.0094

Ponto de fecho simples

unid.



X.30.0110

Espanholeta

unid.



X.34.0020

Vareta espanholeta 1.500 mm

unid.



X.34.0021

Vareta espanholeta 2.400 mm

unid.



X.56.0018

Fecho gancho 3ª e 4ª Folha

Unid.

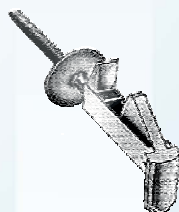

X.51.0006

Segura portada 40 mm

Unid

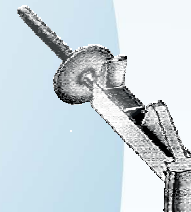

X.50.0008

Segura portada 100 mm

Unid.

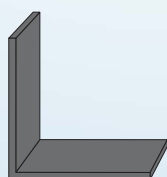

X.10.0012

Esquadro aberto PT.150

Unid.



X.56.0019

Tampa travessa PT.650

Unid.

Unid.

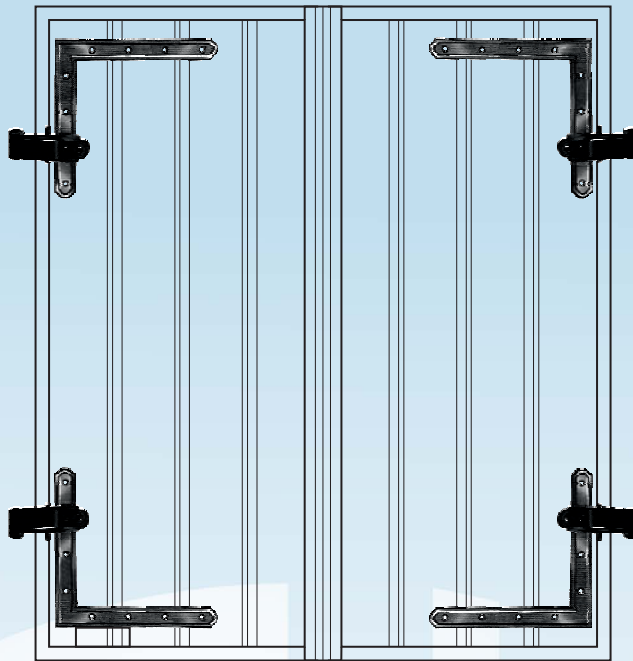

Vista Exterior

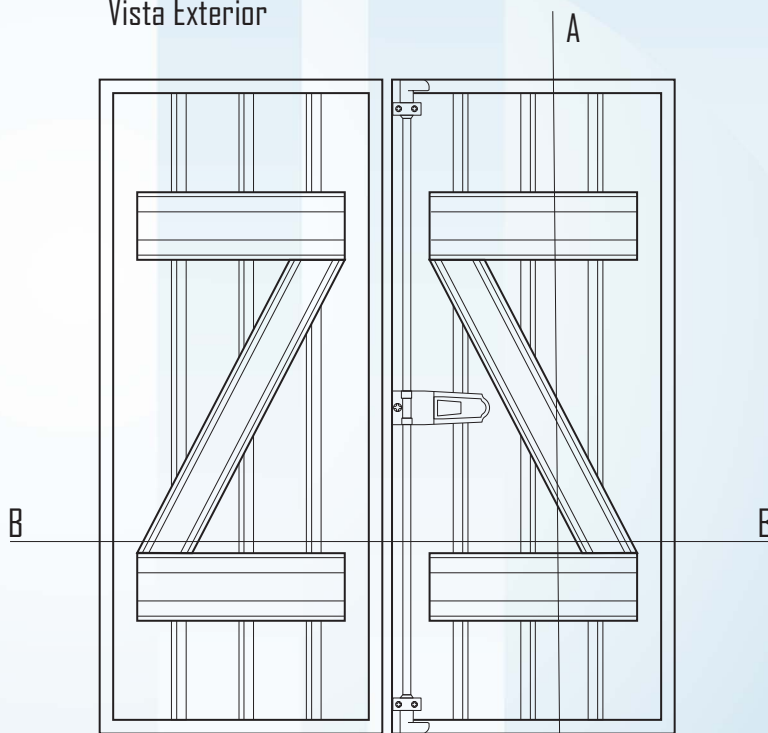
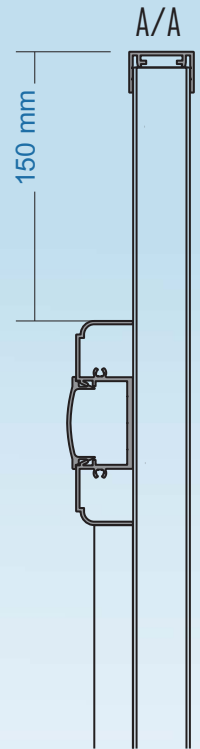

Vista Interior

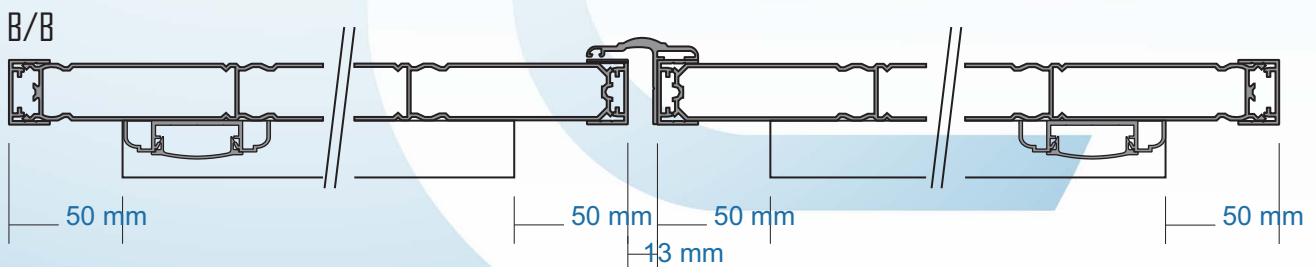
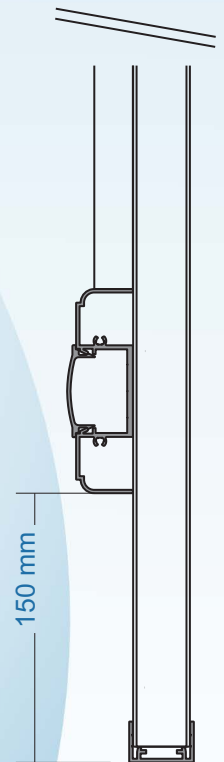



## Mapa de consumos

Acessórios			Janelas				Portas			
			1 folha	2 folhas	3 folhas	4 folhas	1 folha	2 folhas	3 folhas	4 folhas
	Perno Dobradiça Fixação Parede	X.29.0017	2	4	4	4	3	6	6	6
	Dobradiça 1ª folha p/ folha simples	X.29.0018	2	4	2		3	6	3	
	Dobradiça 1ª fl reforçada p/folha dupla	X.29.0019			2	4			3	6
	Dobradiça de folha dupla	X.29.0020			2	4			3	6
	Espelho Angulo para dobradiça 1ª folha	X.59.0092	1	2	2	2	1	2	2	2
	Espelho Angulo complementar	X.59.0094	2(a)	4(a)			2(a)	4(a)		
	Espelho dobradiça intermédia (portas)	X.59.0093					1	2	2	2
	Ponto de fecho simples	X.33.0094	2				2			
	Ponto de fecho duplo	X.33.0093		2	4	6		2	4	6
	Fecho gancho 3ª e 4ª Folha	X.56.0018			2	4			2	4
	Espanholeta	X.30.0110	1	1	1	1	1	1	1	1
	Vareta espanholeta 1.500 mm	X.34.0020	1(b)	1(b)	1(b)	1(b)				
	Vareta espanholeta 2.400 mm	X.34.0021	1(c)	1(c)	1(c)	1(c)	1	1	1	1
	Segura portada 40 mm	X.51.0006	1	2	1		1	2	1	
	Segura portada 100 mm	X.50.0008			1	2			1	2
	Esquadro aberto PT.150	X.10.0012	4	8	12	16	4	8	12	16
	Tampa travessa PT.650	X.56.0019	4	8	12	16	6	12	18	24

(a) - Opcional. A usar em folhas de largura superior a 500 mm.

(b) - Para folhas até 1500 mm de altura.

(c) - Para folhas superiores a 1500 mm de altura.

